

19.ACCESSORY

Accessory	Quantity
User Manual	1PC
Wire	1PC
USB Cable	1PC
Remote Controller	1PC
Warranty card	2PCS



BV9362BI

CONTENTS

*Bluetooth-Enabled
In-Dash Motorized Double-DIN
DVD/MP3/CD AM/FM Receiver
With 6.2" Widescreen
Touch Screen TFT Monitor
And Front Panel A/V AUX Input*

CATALOG

Warmly Suggestion-----	04
Notice Item-----	05
Features-----	06
1.Front Panel Function Instruction-----	07
2.Basic Function-----	08
3.Remote Control Function-----	10
4.Main menu touch operation-----	12
5.RDS User Operation-----	16
6.Radio Operation-----	17
7.Audio-----	19
8.Disc Play Touch Operation-----	20
9.DVD Basic Operation-----	25
10.VCD Basic Operation-----	35
11.CD Basic Operation-----	38
12.MP3/USB/SD Operation-----	40
13.Bluetooth Function Instruction-----	41
14.IPOD READY-----	43
15.Other Play Mode-----	46
16.Trouble Shooting-----	47
17.Wiring Diagram-----	48
18.Specifications-----	49
19.Accessory-----	50

Welcome

Thank you for enjoying our digital car A/V product.

To properly use this product, please go through this instruction manual for installation and operation, put it in a safe place for future use!

WARNING

1. Please keep the disc slot clean, wipe it off when there is some dirty on it, please wipe off the dirty on disk before slot it into the unit. If dirty on disk go into the slot with disc, that will lead unit to slow slot or cannot read disc. In fact ,that is not quality problem. Please ask professional to clean the laser. That will bring you some inconvenience.
2. Playing disc for long time or high volume level will influence the lift of unit. To protect this unit, please work with radio, middle level volume level during long time use.
3. This unit is set up by precision parts. Please do not open the unit or adjust any parts inside unit by yourself.
4. Please do not touch LCD display by hard object to protect in from scratch.
5. TO avoid accident caused by scatterbrain, driver should not operate this unit or watch its screen. If needed, please park the car in a safe place before operation.
6. This unit is for 12V and negative ground system car, please do not connect it directly in 24V truck or bus.

Note: We keep improving this product, if there is any change, forgive us do not announce.

18.SPECIFICATIONS

Power supply ----- DC 12V
Power range ----- 10.8-16.0V DC
Max operate current ----- 10A
Install size ----- 178X153X101MM
Ground system----- Negative ground
Amp Rating ----- **80 WattsX4 Channels**

FM tuner

European frequency range----- 87.5-108MHz
USA frequency range----- **87.5-107.9MHz**
Signal/Noise ratio ----- 55dB
Stereo separation----- 30dB
Search station volt ----- **20-30dBuv**
Distortion rate----- 1.5%

AM tuner

European frequency range----- **522-1620kHz**
USA frequency range----- **530-1710kHz**
Limit noise sensitivity----- 32dB

DVD PLAYER

Signal/Noise ratio----- 70dB
Frequency response----- 20Hz-20KHz

17. WIRING DIAGRAM

This player is equipped with ISO standard connector, please follow below instruction:

- Red - ACC ON (+12V)
- Yellow – 12 V Constant
- Black – Ground wire
- Blue - Power Antenna / Remote Amp Turn On
- Orange – Back-Up Camera Trigger (+)
- Grey/Grey black - Right front speaker (+/-)
- White/White black - Left front speaker (+/-)
- Purple/Purple black - Right rear speaker (+/-)
- Green/Green black - Left rear speaker (+/-)
- Pink – Parking Brake (-)

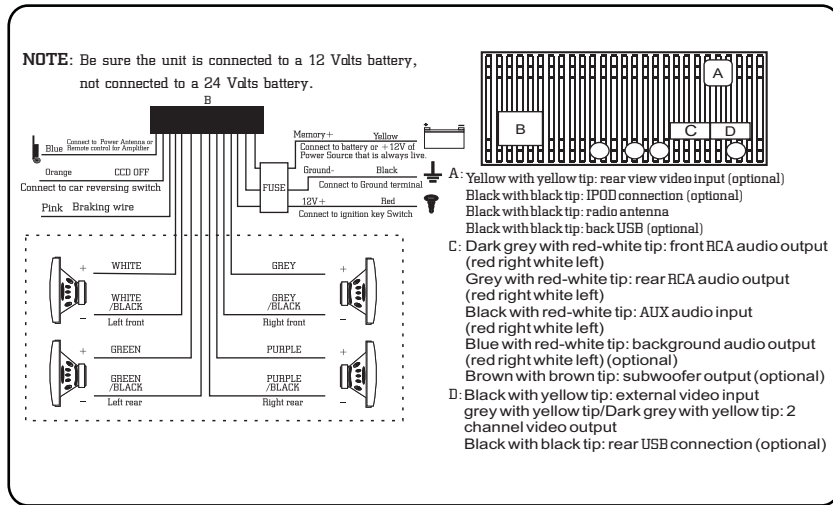

Note:

The "PARKING BRAKE" wire must be connected to the parking brake system of your car. When the parking brake is engages, the LCD will be allowed to view your video. If not, the screen will produce an image saying, "PARKING BRAKE". This is a safety feature designed for the driver not to watch a video while driving. The video output on this unit will not be affected by this.

NOTE

- This unit can play the following disc:

MODE	CONTENT	DISK SIZE
DVD	Sound,image	12CM
VCD	Sound,image	12CM
MP3	Sound only	12CM
CD	Sound only	12CM

Note: 1. This unit is compatible with MP4/DVD/VCD1.0/2.0/3.0 version, DVD, CD-R, CD-RW, MP3, WMA, JPEG.
2. When play DVD, VCD, MP3, CD disc, display will auto identify the disk and show corresponding word. When appear on display, that means no that function, please choose other function. Detailed operation please refer to other related instructions.

- It may lead to accident if you are going to change unit.
- Playing disk during car run on bumpy road will damage laser. Playing substandard disk or damage disk will damage laser.
- The environment of inside car is not good, too much dirty, please clean the laser by laser cleanser timely.
- Do not work under terribly hot or cold environment, please ensure the temperature in car is in -20°C ~ 60°C.
- During operation, if appear on LCD, that means unit do not support that function, operation is invalid.
- When unit is showing some abnormal, please refer to TROUBLE SHOOTING in this instruction manual, If you cannot find any solution, please press RESET to resume to initial status.

FEATURES

DVD PLAYER

- 1.MPEG-4 Decoder Technology
- 2.Compatible with MP4(AVI/5.X),DVD(DVD-R/DVD-RW),VCD,SVCD,CD-RW,WMA,MP3,JPEG
- 3.Supporting Multiles Subtitles,Angles,Languages
- 4.Child lock function
- 5.4-Channel Audio Output
- 6.Pause, play, UP/Down, Stop, Zoom, PBC Function

RADIO

- 1.AM/FM Radio Tuner
- 2.30 Radio Preset Stations (18FM, 12AM)

BULETOOTHFUNCTION

- 1.Bluetooth wireless transfers
- 2.Displaying bluetooth paring and connection status, call status, and caller's ID
- 3.Fast performance, fast connection, accurate and sensible search of devices in range
- 4.Support A2DP, AVRCP, HS/HF for handing calls and playing music

16.TROUBLE SHOOTING

PROBLEM	CAUSE	SOLUTION
Can not power on	Check whether power fuse melt or not	Change fuse same as the old one
	Some factor cause MPU wrong operation	Press RESET button on the panel by pen point, then, power on
After ignition switch off, setting information all lose	Wrong connection between ignition line ACC and power line anode pole BAIT	Reconnect line
Remote control no function	No enough power supply from battery	Change battery of remote control
Poor performance of radio station	Improper set of length of antenna, poor connection of antenna grounding	Check whether antenna is connected or not, or poor connection
Can not load disc	There is a disk inside	Eject disk ,then, slot in new disk.
Can not play disc	Disc is scratched	Change new disc
	Put wrong side of disc into unit	Slot in the disk with sign side up
	Lens has dirty	Clean lens by lens clean disc
Can not switch language/subtitle	There is only one language/subtitle in disc	If disk is not with multi-language/subtitle, it cannot switch language/subtitle
No image	Video line between unit and TV is not properly connected	Reconnect lines

15. OTHER PLAY MODE

AUX IN OPERATION

- 1) Press "Source" button on remote control or touch "AUX" on the touch screen, switch to AUX mode.
- 2) Make video input plug connect to AUX video input outlet, audio input connect to AUX audio input outlet.
- 3) This unit only supply 1pcs video input & 1 pair audio input.

CCD (Car backsight function)

- 1) If there is a car back camera on your car, please connect car back control line "BACK" to your car camera control terminal, and connect video input line to the video output terminal of your car camera.
- 2) When car is back, the unit will auto switch to CCD mode, and there is a "  " appeared on the screen.
- 3) You can set CCD image according to your car's own position in general setting mode.

1. Front Panel Function Instruction

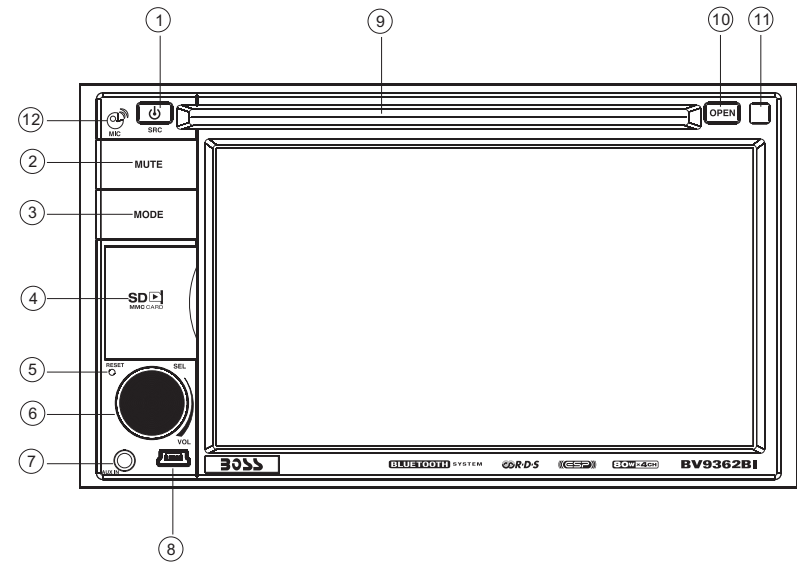

1. SRC Button
2. MUTE/TFT on/off Button
3. MODE Button
4. SD Slot
5. RESET Button
6. SEL/VOL Button
7. AUX IN
8. USB Slot
9. Disk Load Slot
10. OPEN Button
11. Remote Control Receiver
12. MIC Input

2.BASIC FUNCTION

1.SRC Button

Press this button shortly to power on, press this button longer to power off.
In normal situation, press SOURCE button can return to the main menu.

2.MUTE/TFT on/off Button

Press this button to shut off sound output, repress this button to resume sound output;
Press this button longer to turn on /off TFT LCD display.

3.MODE Button

When the unit is power on . Repeat press this button can switch to different function mode as following picture

Note:When the device without connecting to USB,SD,CDC or DVD no disc inside ,the system will automatically skip these related working mode.

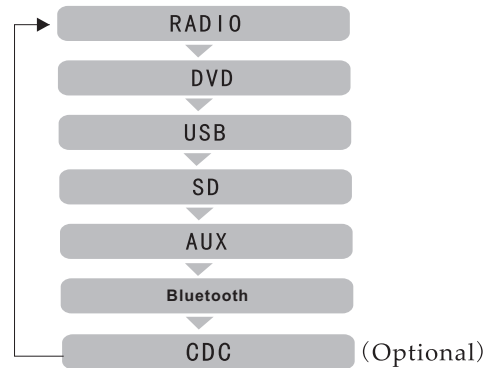

4.SD Slot

This is a high-speeds transmission interface, which can read high-capacity data in MP3 or MP4 format.

5.RESET Button

Press this button and this unit will be restored to the initial state.

6.SEL/VOL Button

Turn this button can adjust the volume,Press this button can adjust the mode according to personal likes.

“Ipod” Video mode setting:

Select “Video” on the main menu of the “ipod” player. If not ready the video mode setting, will never play the video file. The setting instruction as below:

- (1) TV Out : ON
- (2) TV signal : PAL/NTSC
- (3) Full Screen: OFF

When selecting video mode, must switch to “ipod” operation mode. Unless the unit will only with voice but not picture.

About “ipod” players operation instruction, please refer to the ipod player's instruction manual.

After plugging in ipod player and switch to ipod mode, and enter the ipod UI screen. At that time ipod player will display the “Sunplus” logo as the picture below.

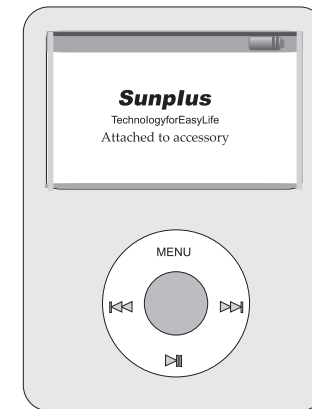

When you see this picture, the ipod player is out of control
Above operation instruction is according to the “ipod” edition 1.3

Note:

Since “ipod” edition keeping up-date, some edition software of the “ipod” player may not working with this unit, Sometimes, may happen compatible problem. Sorry for the inconvenience.

For example: As PIC 2, touch certain category you want, then touch “ok” to enter the category. After that, touch any file to play. It shows like the PIC 3 below.



(PIC 2)

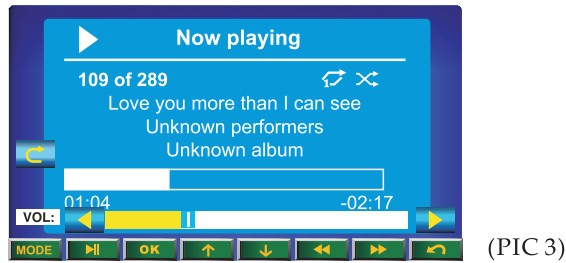

(PIC 3)

4. Video Play

In the files menu, touch any part of the touch screen, then touch the “MOD” on the screen control (see PIC 4) to enter the “ipod” mode. Main menu, picture 4:

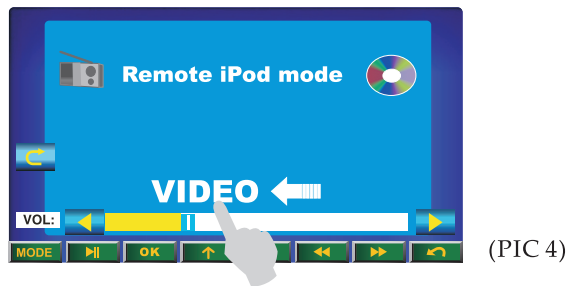

(PIC 4)

Touch “VIDEO” on the main menu and the unit will switch to " ipod "operation mode, while, control the “ipod” player, and select the video file you want to play, while the video picture will transfer to the unit screen. During the unit playing the video, “ipod” player must set as Video mode, if not the unit only with audio but not video.

7. A/V AUX External Input

External connection for A/V input.

8. USB Slot

Connect the USB memory to this socket, and the unit can play music format files supported by this unit in the USB memory.

9. Disk Load Slot

Opening for disks to enter or retreat.

10. OPEN Button

Press this button can eject the disc

11. Remote Control Receiver

It is able of receiving infrared signals launched by the remote control matching the unit.

12. MIC Input

Bluetooth MIC input.

3. REMOTE CONTROL FUNCTION

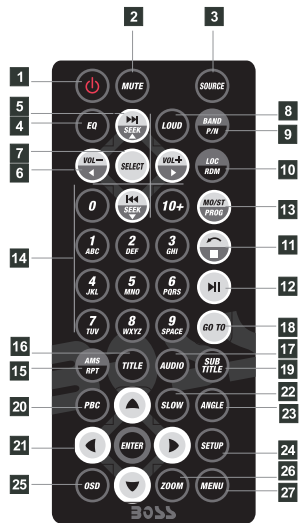

3. SOURCE Button

Press this button to choose audio sources.

4. EQ Button

Press this button to choose POP, ROCK, CLASS, EQ off.

5. SEEK + (▶▶) / SEEK - (◀◀) Button

Press this button to manual turning, speed or quick back, previous song and next song.

6. VOL + (→) / VOL - (←) Button

Press this button to increase or decrease volume level.

7. SEL Button

Press this button to choose sound feature.

8. LOUD Button

Press this button to startup LOUD function.

9. BAND - P/N Button

In radio mode, press this button to choose band. In VCD, DVD mode, press this button to choose AUTO, PAL or NTSC system.

10. LOC/RDM Button

In radio mode, press this button to switch between local and direction. In VCD, CD mode, press this key to randomly play.

11. STOP Button

Press this button to stop playing.

12. PLAY/PAUSE Button

Press this button to switch between play and pause. In stop mode, press this button to play.

13. ST/ PROG Button

In radio mode, press this button to choose stereo or mono station. In audio mode, it can help STOP button to programmed play.

1. POWER

Press once to switch on, press again to switch off.

2. MUTE Button

Press once to turn off audio output, press again to resume volume level.

1 POWER ON/OFF	15 AMS/RPT
2 MUTE	16 TITLE
3 SOURCE	17 AUDIO
4 EQ	18 SET PLAYING TIME
5 SEEK+/SEEK-	19 SUBTITLE
6 VOL+/VOL-	20 PBC/MENU
7 SEL	21 UP/DOWN/L/R ENTER
8 LOUD	22 SLOW
9 BAND/ P/N	23 ANGLE
10 LOC / RDM	24 SET UP
11 STOP	25 OSD
12 PLAY/PAUSE	26 ZOOM
13 ST/PROG	27 MENU
14 0-10+	

14. IPOD READY

1. Enter (ipod) Mode:

Before enter the ipod mode, please link your ipod player with the unit. Then, touch "ipod Icon" enter the ipod mode. If the ipod player have not link with the unit, the unit cannot recognized the external ipod player, the unit will return to the main menu. If the unit is working in any other mode (e.g. DVD, Radio, etc), after you plug on the ipod player and linked well, then the unit will switch to ipod mode automatically.

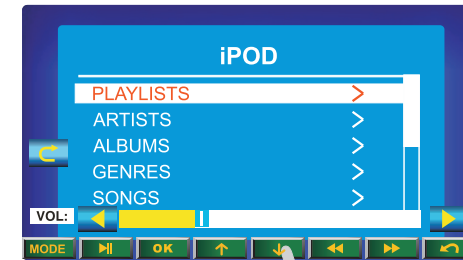

(PIC 1)

(Files Menu)

This system divide the files into 8 types of categories. Just touch the category you want, the unit will enter the certain main and play the first file in the certain category

2. Touch Buttons:

MODE	Mode Switching
▶▶	Play/Pause
OK	Confirm/Ok
↑	Cursor Up
↓	Cursor Down
◀◀	Backward
▶▶	Forward
↶	Return to last OSD
↷	Back main menu
VOL	Increase or decrease volume level

3. Audio play:

When you see the files menu (as PIC 1 above), you touch the middle of the panel, then you can see the "control menu" appear on the screen. You can selecting by touching the button ▲ or ▼

4. Incoming display

If there is incoming, under any mode, system will automatically switch to Bluetooth hand-free function interface. And it have incoming sound and incoming display note you to answer telephone.

5. Answer phone

When there is an incoming call, Touch  to connect and touch  to refuse to connect.

6. Call logs

Under Bluetooth mode, press call logs button will enter call logs interface, as following:

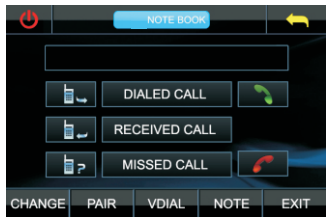

- (1) Press [**dialed calls**] function position, you will search telephone number which you have dialed.
- (2) Press [**received calls**] function position, you will search telephone number which you have answered
- (3) Press [**missed calls**] function position, you will search telephone number which you have missed.

14. 0 - 10 + Button

Press this button to choose desired song, section, preset stations.

* Decimal numbers, for example the 19th song, press 1,9 button;

* Centesimal numbers, for example, the 120th song, press 1,2,0 button.

15. AMS / RPT Button

In radio mode, press this button to browse stored stations. In audio mode, press this button to play repeatedly.

16. TITLE Button

In DVD mode, press this button to play back to the top menu of disc.

17. AUDIO Button

In DVD mode, press this button to switch language of dialogue. In VCD mode, press this button to choose left track, right track, and stereo.

18. SET Playing Time

In DVD mode, press this button, you can define playing time.

19. SUBTITLE Button

In DVD mode, press this button to switch language of subtitle.

20. PBC Button

In VCD mode, press this button to display all song menus, work with number button to choose songs.

21. UP, DOWN, LEFT, RIGHT, ENTER Button

In DVD mode, press this button to move cursor up, down, left, right to choose item in menu. Press the enter button to confirm choice.

22. SLOW Button

In audio mode, press this button to slow backward and slow forward.

23. ANGLE Button

In DVD mode, press this button to change play angle.

24. SETUP Button

In audio mode, press this button to choose different set items.

25. OSD Display

Press this button to display the title chapter and the left time.

26. ZOOM Button

In DVD/VCD mode, press this button to ZOOM in.

27. MENU Button

Press button to back to the main menu.

BATTERY CHANGE

When control distance of remote control becomes shorter or no function, please change battery. Please confirm polarity before change.

One hand press stopper, then pull out battery.

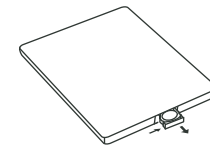

Put battery into controller.

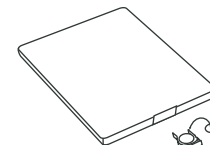

Insert battery holder into controller.

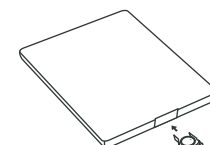

4. MAIN MENU TOUCH OPERATION

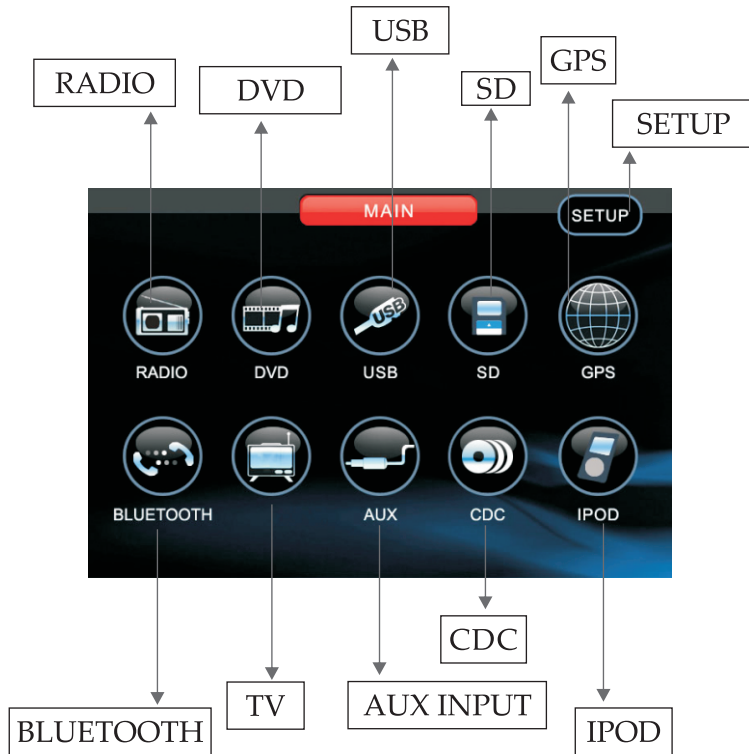

† Notice: When there is no disc, USB, SD, there is a tip sound when you click those functions .

13. BLUETOOTH FUNCTION INSTRUCTION

1.Enter/exit

Touch on main menu interface to enter Bluetooth interface;

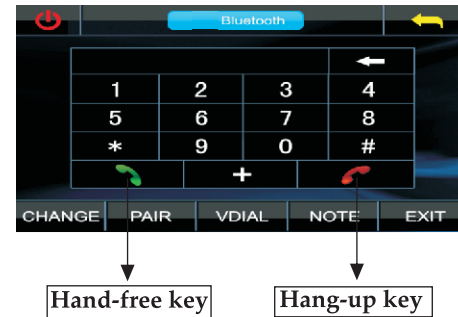

Press will exit Bluetooth interface and return main menu interface.

2.Match/connection

If you want to use Bluetooth function, you must establish a connection first. Matching unit with Bluetooth cell phone..

[operation way]

Set your cell phone to Bluetooth mode, and use cell phone to search equipment. After Bluetooth equipment of this unit has been search by cell phone, cell phone will Ask you for Bluetooth matching password.. touch matching setup button on unit and input Bluetooth Password(0000) on cell phone and confirm it. Cell phone will note to whether authorize Connection with this equipment. Please select "yes" . cell phone will auto establish connection with Bluetooth of the equipment within 20seconds. Under any mode(radio, DVD etc. if there is an incoming call to your cell phone, the unit will switch from current statue to Bluetooth. It will automatically restore current mode after hang-up.

Note: if Bluetooth equipment matching with this unit correctly, it will display "LINK OK" otherwise it display "NO LINK".

3.Dial

You can use cell phone or touch digital key on display to input telephone number. If input wrong, you can press to delete. After enter telephone number, press to dial.. Touch to hang-up.

During call period, press "CHANGE" will let phone sound switch between speaker of unit and speaker of Phone.

12. MP3/USB/SD OPERATION

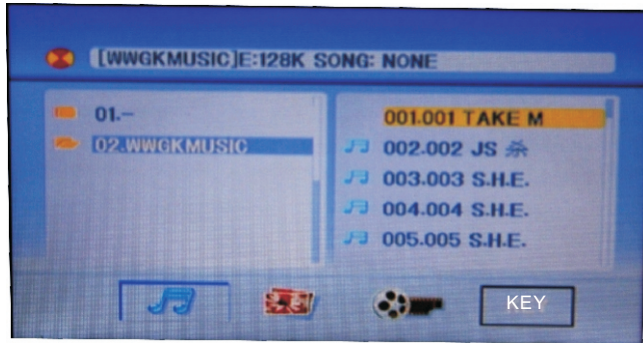



1. Insert SD card or USB, MP3 disc; click the name of the song directly to select the song you want to broadcast. If there are pictures or video document in the disc or SD card, you can select the relative icon to broadcast.

2. Playback MP4 files, the touch screen  into the MP4 format, you can click directly Or through remote control and touch button to choose the direction you need MP4 repertoire.

3. This interface of DVD touch function will display if you click on KEY (Please refer to the instruction of DVD touch function)

NOTE: By a remote control  stop button to return to the playback screen.

1. Pause play

In playing mode, press  button on remote control, or  touch button on display to pause. Press again to back to normal play.

2. Previous / next song play

In playing mode, press SEEK + / SEEK - on remote control, or  /  touch button on display to choose previous/next song.

3. Speed forward / backward play

Press SEEK + / SEEK - button on remote control, or  /  touch button on display to speed forward or backward playing.

4. Repeatedly play

In CD mode, press AMS/RPT button on remote control, to startup following, repeat Mp3 disc: Single song repeat → Directory repeat → Repeat play off.

OSD SETUP

In the main interface, touch  Into following interface.

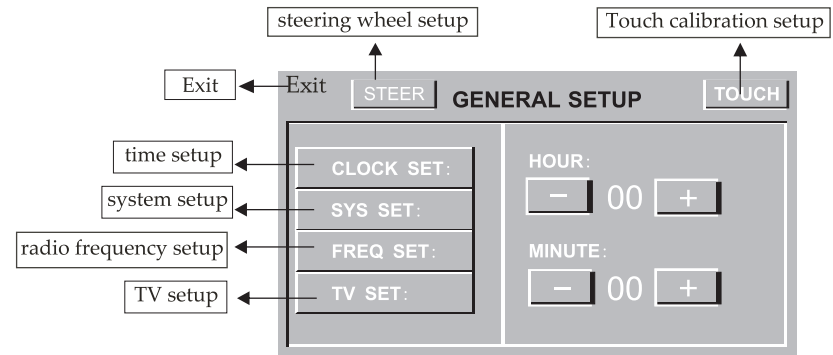

Touchcalibration:

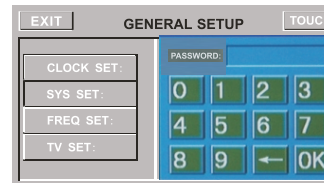

System Setup: click this button, then input password "888888". Click "OK" into system setup, press relevant button to choose on/off. Press "OK" button to confirm.



Touch the center of "+" to calibrate when the position misgrated.

Radio frequency setting

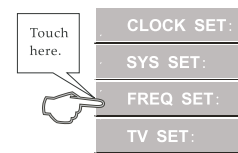

According to different area to choose frequency, pls as below pic:



TIME DISPLAY AND ADJUST

Time display: Touch main menu into adjust mode, and press time setup button, then the corresponding function will be displayed in yellow words.

(1) Press "+" on hour setup to add hour, press "-" to reduce hour;

(2) Press "+" on minute setup to add minute, press "-" to reduce minute.

NOTE: Touch the correspondence function, it will be showed in green background.

The unit include two times system: Europe time (24 hour setup), America time (12 hour setup), It indicate morning time while show the AM mark, and it indicates afternoon time while show the PM mark.

Learn steering wheel control operation as follows



1. pls connect the positive pole/negative pole from origin steering wheel control wire rightly to our unit, power on that unit to that menu as above picture showing, click the setup button.

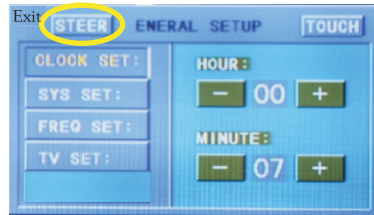

2. after enter into the setup, click "steering wheel" button like as picture show.

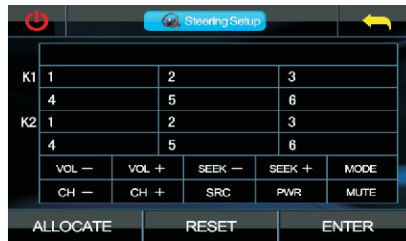

3. enter into steering wheel control setup manu.



4. make a note for origin car steering wheel control function.

10. CD program play

In CD mode, you can set the sequence of playing by the program function, the operation is as follow:

When CD is playing, press ST/PROG button, then the display shows:

PROG	TC	TC	TC	TC			
1	__ : __	5	__ : __	9	__ : __	13	__ : __
2	__ : __	6	__ : __	10	__ : __	14	__ : __
3	__ : __	7	__ : __	11	__ : __	15	__ : __
4	__ : __	8	__ : __	12	__ : __	16	__ : __
		PLAY		DELETE			

Input the NO. of the song you want to program by the remote control, program the first song, input your desired song, for example, the sixth song, and press number button 6 on the remote control. Program the second song, press ▼ button move the cursor to 2[_ _]. Input your desired song, for example, the ninth song, press number button 9 on the remote control. Press ►► button to program play.

Back to the normal mode, press the ST/PROG button, then press ►► button,

Note: This function can only be worked by the remote control.

11. CD BASIC OPERATION

Slot in CD disc unit will play it automatically. If disc is in slot, press DVD touch button on main menu can to play.

1. Repeatedly play

In CD mode, press AMS/RPT button on remote control, to startup following, repeat CD disc: Single song repeat → Repeat play off.

2. Speed forward / backward play

Press SEEK + / SEEK - button on remote control, or ►►/◄◄ touch button on display to speed forward or backward playing.

Note: Hold above button a bit longer to operate.

3. Previous / next song play

In playing mode, press SEEK + / SEEK - on remote control, or ►►/◄◄ touch button on display to choose previous/next song.

4. Pause play

In playing mode, press ►|| button on remote control, or ►|| touchbutton on display to pause. Press again to back to normal play.

5. Stop play

In playing mode, 1) Press ■/> button on remote control to enter the pause mode, the position will be stored in unit. At that time, press ►|| button on remote control or touch button on display to resume playing at the stored position.

2) Press ■/> button on remote control twice to enter into stop mode, here, press ►|| button on remote control or touch button on display, unit will play from the first song.

6. OSD

In playing mode, short press OSD on remote control to show all information of present disk.

7. Randomly play

In CD mode, press LOC/RDM button on remote control, to instantly play each song. Press again to back to the normal play.

8. EQ mode

1) This function can only be worked by remote control.

2) When playing CD, press the " EQ " button on the remote control, you can choose the sound mode.

9. OPEN

Press OPEN button on panel to eject disc.

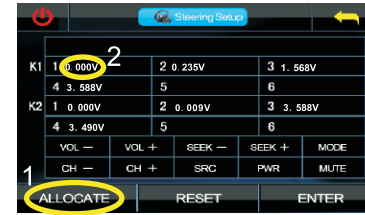

5.(1)press the button step by step on car steering wheel control and write it down,then click "allocate" button on our unit like as picture show (2) click number"1" to choose that function according to car origin steering wheel control function

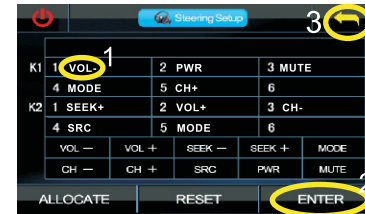

6.(1)as picture indicated,click "voice" in the screen(position 1), then choose the same word in the choose screen.
(2) click the " confirm " button in the screen, then finish the setup.
(3) like picture show, click " confirm " button in order to keep save, click "3" to return

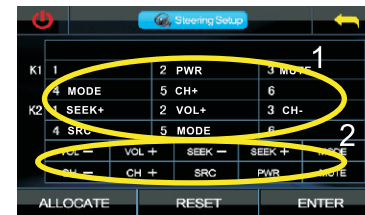

7.like picture shows, click position 1 to choose what function button you revise , click position 2 to make revise to them.



8.click area 1 to delete all steering wheel control , and reset all steering control function under re-do the above mentioned

5.RDS USER OPERATION

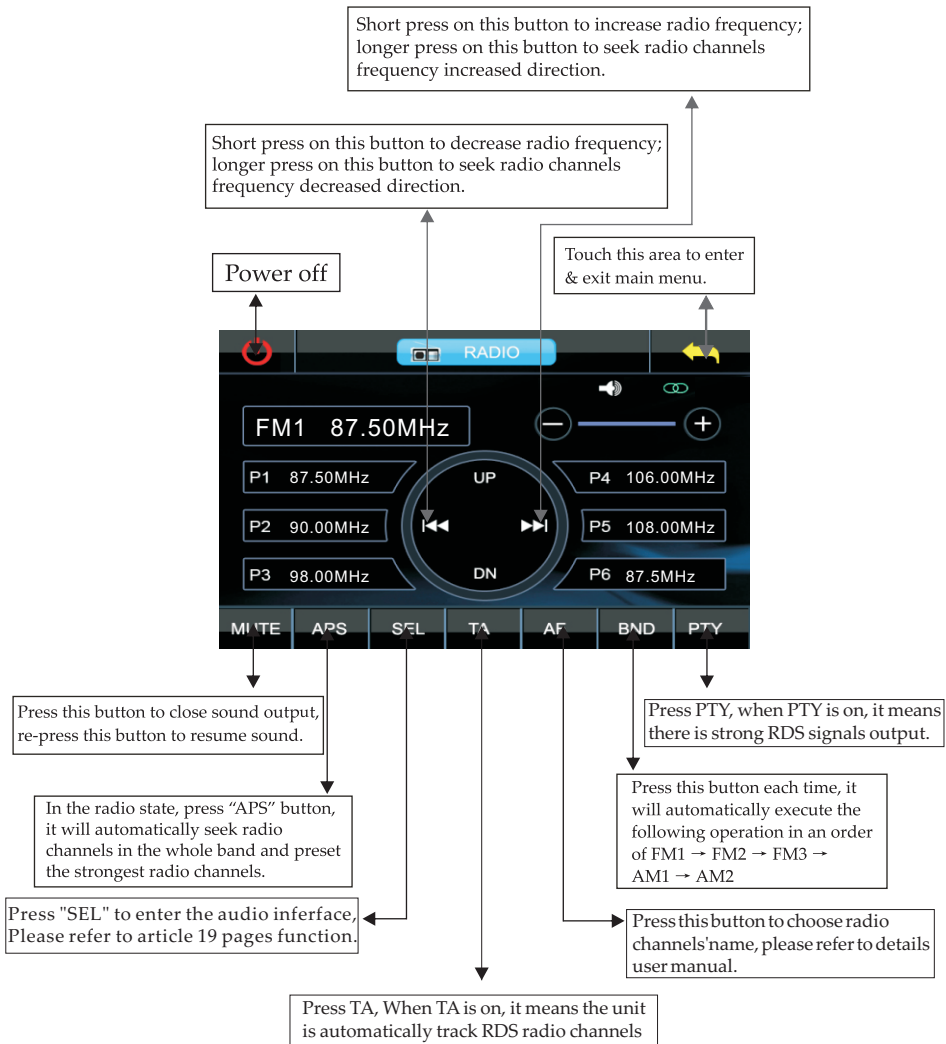

15. VCD program playing

In VCD mode, you can set playing sequence of songs by program play function. The program playing operation steps are as follows:

In VCD mode, press ST/PROG button, display will show;

PROG	TC	TC	TC	TC			
1	__ : __	5	__ : __	9	__ : __	13	__ : __
2	__ : __	6	__ : __	10	__ : __	14	__ : __
3	__ : __	7	__ : __	11	__ : __	15	__ : __
4	__ : __	8	__ : __	12	__ : __	16	__ : __
		PLAY		DELETE			

Input the songs which you want to programmed by the number buttons on remote control. For example: Program the first song, input your desires song, for example, the fourth song, and press number button 4 on the remote control. Program the second song, press ▼ button move the cursor to 2 -- . Input your desired song, for example, the eighth song, press number button 8 on the remote control. Press ►► button to program play. Back to the normal mode, press the ST/PROG button, then press ►► button.

Note: This function can only be worked by the remote control.

8. OSD

In playing mode, short press OSD on remote control to show all information of present disc.

9. Number button

In VCD mode, press 0-9 number button to input song. For example, you want to choose 13th song, press 10+ button, and then press 3 button once to play 13th song.

Note: This function can only be worked by the remote control.

10. Repeatedly play

In playing mode, press AMS/RPT button on remote control, to startup following, repeat function. Single song repeat → Repeat play off.

Note:

- 1) When playing VCD disc, if PBC is on, no repeat function.
- 2) After unit is power off or mode is switched to other playing mode except VCD mode, if you switch back to VCD mode, repeat playing will be cancelled.

11. Randomly play

In VCD mode, press LOC/RDM button on remote control, to instantly play each song. Press again to back to the normal play.

Note: When playing VCD disk, if PBC is on, RDM will not work .

12. Switch Track

In VCD mode, press AUDIO button on remote control to switch track as following sequence:



13. OPEN

Press OPEN button on panel to eject disc.

14. PBC (MENU) play

In VCD mode, press this button then play the PBC and display will show whole menu in disk, work with number button to choose song. When you are playing either song of the PBC, and you want to stop to select another song, press the button to turn off.

Note:

- 1) This function can be worked by the remote control
- 2) PBC is suitable for the SVCD and VCD 2.0 disc.
- 3) In PBC mode, you can not press number button only to choose song.

6. RADIO OPERATION

1. Band selection

In radio mode, press BAND button, BAND/P/N button on remote control, or touch position of switch bank position every time to choose band, the sequence is as follows:

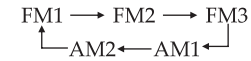

2. Adjust frequency

Manually adjust frequency:

Press SEEK + button on remote control, or ►► touch button on display shortly every time, frequency will increase one step by one step till you get desired frequency. Press SEEK - button on remote control, or ◀◀ touch button on display shortly every time, frequency will decrease on step by step till you get desired frequency.

Search station:

Press SEEK + / SEEK - button on remote control, or ►► / ◀◀ touch button on display longer every time to search station in up/down direction. When get one station, it will auto stop searching.

3. Browse / Auto search and store station

- 1) In radio mode, press AMS/RPT button on remote control, or APS button on display shortly to browse preset station on 1-6;
- 2) In radio mode, press AMS/RPT button on remote control, or APS button on display longer to auto search in whole band from present frequency and store 6 most strong frequency on 1-6;
- 3) This unit has FM1, FM2, FM3, AM1, AM2 band, Each band can preset 6 stations, total 30 preset stations.

Note: After preset station, unit will cancel the former preset stations.

4. Mono/Stereo Selection

In radio mode, press ST/PROG button on remote control or ST touch position on display to choose mono/stereo program.

Note: In radio mode, start up the stereo function automatic, touch the ST button again on the display, the TFT display will show the ST OFF & MONO mark, that is to turn off the stereo. When the right under foot appear the MONO mark, it show the MONO on.

5. Manual preset and store station

In radio mode, press 1-6 button on remote control, or 1-6 position on display longer to store preset frequency into preset channel. For example, the present frequency is 89.8MHz, press 2 button longer, then 89.8MHz frequency is stored in 2 channel.

RDS

1. EON (RDS Mark)

Indicate main unit is on auto tracking RDS mode.

2. AF (RDS Auto Tracking Mark)

Indicate radio is auto tracking RDS channel.

3. TA (RDS Signal Increasing Output)

Indicate RDS channel have signal increasing output.

4. TP (RDS Channel Stereo Mark)

Indicate RDS channel is on stereo playing mode.

5. POP.M (RDS Channel Mark)

Indicate RDS channel name.

I. RDS Tracking System

Press AF button in FM mode, and then press ◀▶ last 2 seconds, RDS will auto search channel up and down, it will stop searching when RDS channel be founded, but "AF" will keep remaining on the screen and waits for the next traffic emergency report.

II. RDS Tracking on Playing Mode

In playing mode, "AF" tracking system keeps on opening and waits for traffic emergency report.

1)PTY: RDS button, press once will show music mode POP, press 1-6 function memory button, every group have 2 channel.

POP M	ROCK M	EASY M
LIGHT M	CLASSICS M	OTHER M
JAZZ	COUNTRY	NATION

2)Press PTY button twice and then press 1-6 function memory button, every button have 3 channel.

NEWS	AFFAIRS	INFORMATION	SPORT
EDUCATION	DRAMA	CULTURE	SCIENCE
CHILDREN	SOCIETT	TELIGION	PHONING
TRAVEL			

Note: RDS channel in broken line is available.

AF: RDS auto search button, in radio mode also can press this button shortly auto tracking RDS channel, press this button shortly can cancel RDS function.

TA: In RDS mode, press this button can output TA signal, and check RDS channel is exist or not, if no RDS signal TFT will show "NO. TA. TP".

10. VCD BASIC OPERATION

Slot in VCD disc, unit will play it automatically. If disc is in slot, press DVD touch button on main menu can to play.

1. Pause play

In playing mode, press ▶II button on remote control, or ▶II touchbutton on display to pause. Press again to back to normal play.

2. Stop play

In playing mode, 1) Press ■/> button on remote control to enter the pause mode, the position will be stored in unit. At that time, press ▶II button on remote control or touch button on display to resume playing at the stored position.

2) Press ■/> button on remote control twice to enter into stop mode, here, press ▶II button on remote control or touch button on display, unit will play from the first song.

3. Speed forward / backward play

In playing mode, press SEEK + button on remote control, or ►► touch button on display to speed play.

When you need quick back, press SEEK - button on remote control, or ◀◀ touch button on display to quick back play.

Note: Hold above button a bit longer to operate.

4. Previous / next song play

In playing mode, press SEEK + / SEEK - on remote control, or ►► / ◀◀ touch button on display to choose previous/next song.

5. Switch system

In playing mode, short press the BAND/P/N button on remote control, to select PAL, AUTO, NTSC TV system.

Note: This function can only be worked by the remote control.

6. Slow play

Press SLOW button on remote control to slow play. The level of slow playing is as follows. Sequence is :

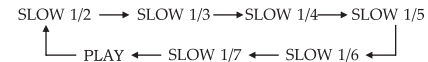

Note: This function can only be worked by the remote control.

7. Zoom in / Zoom out

Press ZOOM button on remote control to zoom in / zoom out the picture. The levels are as follows:



Note:

1. This function can only be worked by the remote control.
2. Image which is zoomed in can be moved by up/down/left/right cursor to move.
3. Image which is zoomed out cannot be moved.

SPEAKER SETUP

1. Press ▲ or ▼ button

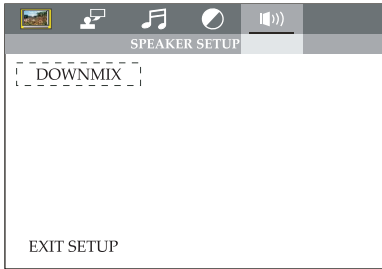

2. Press ▲/▼/◀/▶ button, then to enter.

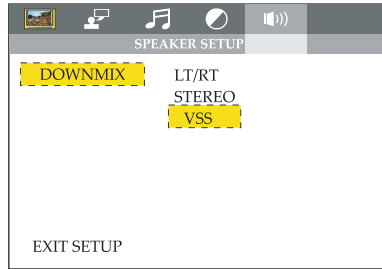

7. AUDIO

Press "version set up" to enter the interfaces as below:

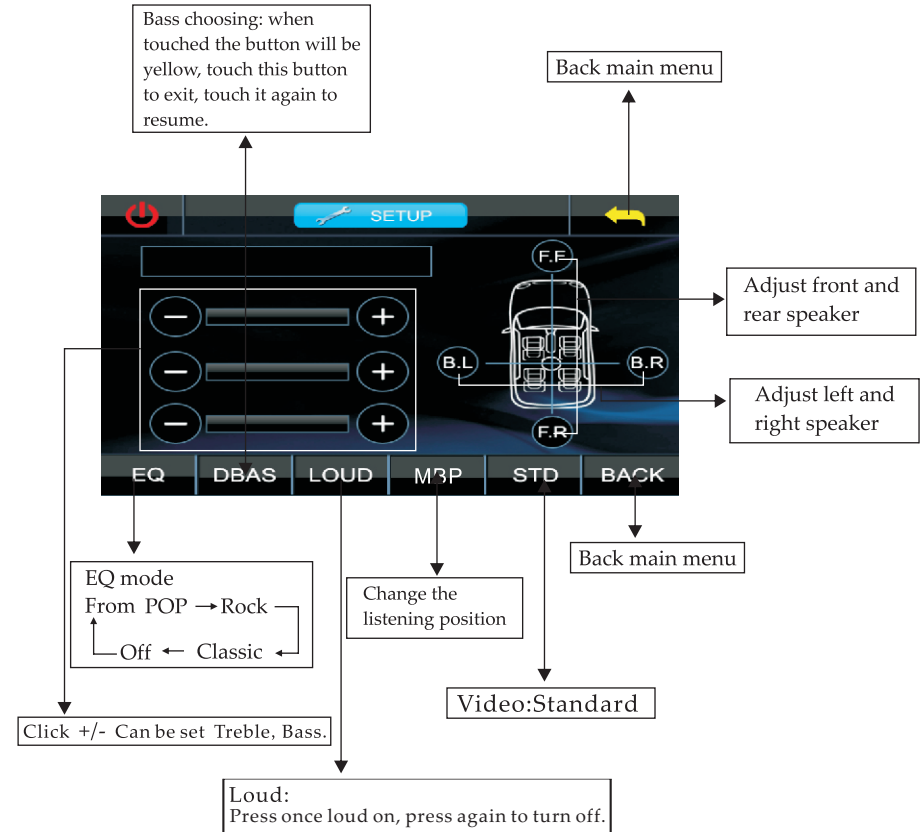

8. DISC PLAY TOUCH OPERATION

When playing disc, touch any position of the screen, it will display the function menu; touch the menu and the operation of relative function will display.

Note: When loading a disc, touch screen function can not be used.

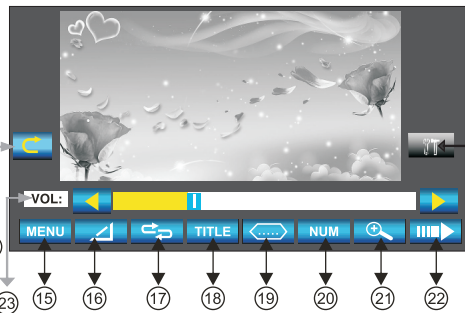
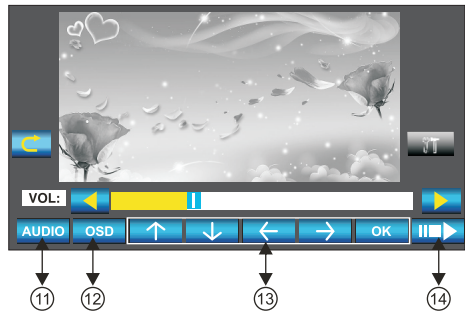
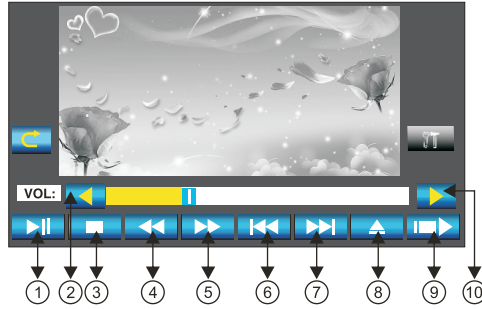

1. Click to choose play/pause
2. Click to reduce the volume
3. Click to stop playing
4. Click to choose the speed of quick back
5. Click to choose the speed speeding play
6. Click to leap backwards to play
7. Click to leap upwards to play
8. Click to exit
9. Click to enter the next page to setup the menu
10. Click to increase the volume
11. Audio
12. Click to display title, chapter, the time already played, the time left
13. At MP3 mode, press this button so you can move the cursor to left/right / up/down and select the songs which in the system menu. then press "OK" button to enter.
14. Click to enter next page set up menu
15. In DVD mode, touch this button to return the directory menu.
16. Click this button to switch to different angles of playing picture in the disc.
17. Repeat play
DVD: Title Repeat → Chapter Repeat → Repeat play off
VCD: Single song repeat → Full disc repeat → Repeat play off
MP3: Single song repeat → Directory repeat → Repeat play off
18. Click on this button to enter title menu
19. Click this button to choose language,
20. click this button and the screen will display 0-10 button.
21. Click this button to ZOOM in/ ZOOM out the picture.
22. Click to enter the menu of operation for touching.

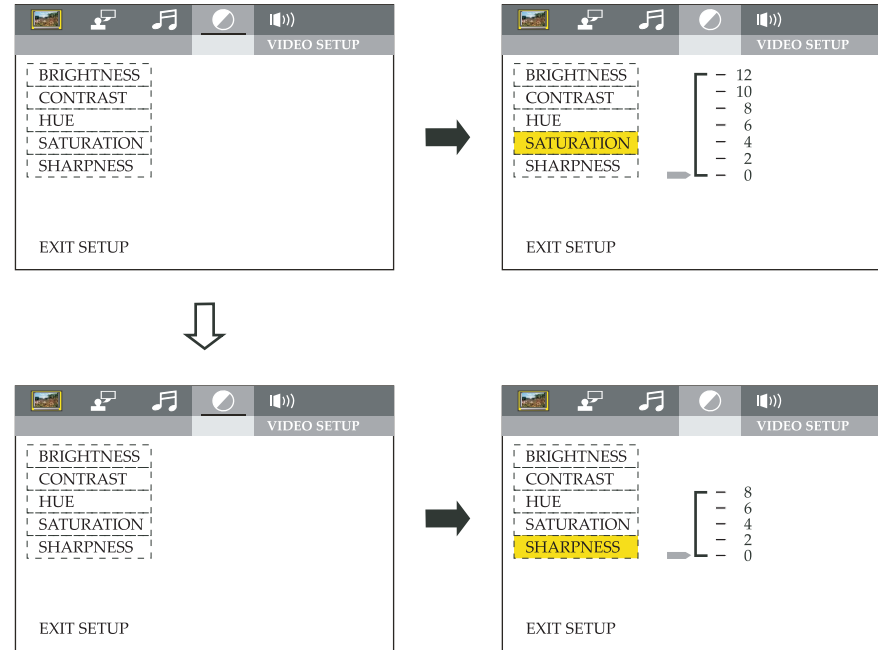

VIDEO SETUP

1. Press ▲ or ▼ button

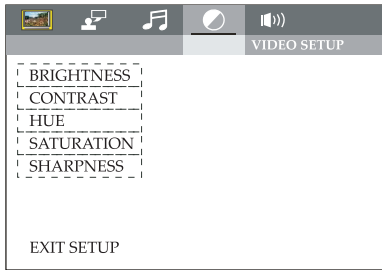

2. Press ▲/▼/◀/▶ button, then to enter.

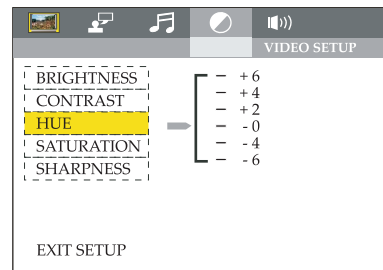
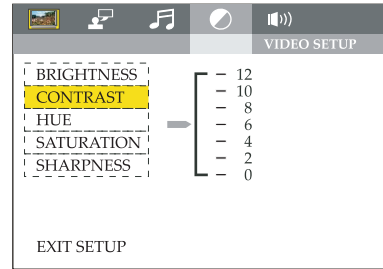
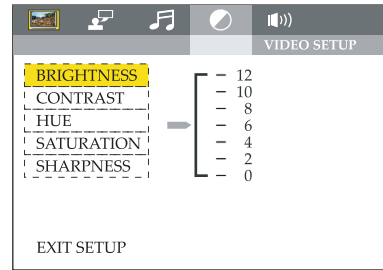

23. Click this to choose mode as below:

VOL→BASS→TRE→BAL→FAD, after your desired mode is selected, touch VOL+/VOL- to adjust the volume.

24. Back main menu

25. Color adjustment

26. Click to select your desired song or chapter

27. Return to the menu one level

Note:

1. When playing VCD, if PBC FUNCTION is on, repeat play is not available.
2. PBC is only suitable for VCD.
3. For VCD disc with play memory, you can use the PBC function;
4. Press PBC in the remote control, Play/Off PBC, press one time to play from the first song;
5. When PBC is on, you can choose speed forward or backward, leap forward or backward, but repeat play is not available.
6. When PBC is on, choose casual play, scan play or search play, PBC function will close automatically.

DVD MODE

✦ In DVD interface, touch setup"  "button into the audio/video setup interface as following.

AUDIO SETTING ON TOUCH SCREEN

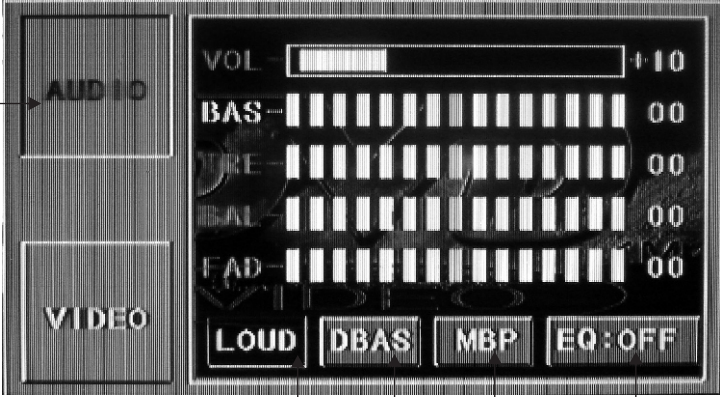

Audio selection:
VOL → BAS → TRE → BAL → FAD
↑
When using this function, the position bar will be highlighted.

EQ mode: Touch the button to change settings:
pop → ROCK ← CLASSIC → OFF

Change the listening position

Bass choosing: when touched the button will be yellow, touch this button to exit, touch it again to resume.

Loud choosing: this function is defined open, when it is touched at the first time, the loud function will be closed, at the same time, yellow light disappear.

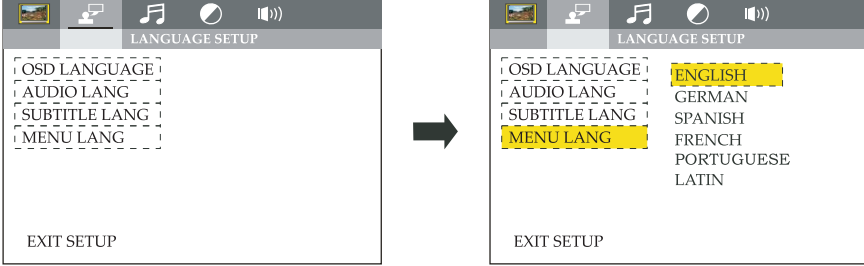

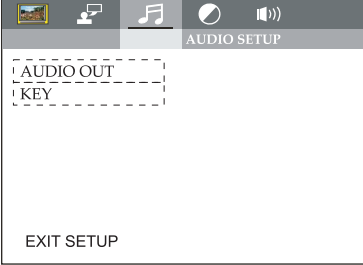

AUDIO SETUP

1. Press ▲ or ▼ button

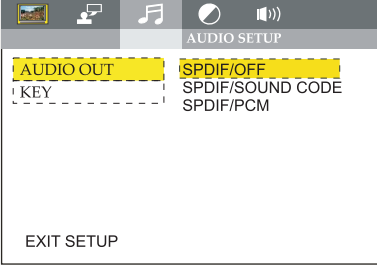

2. Press ▲ / ▼ / ◀ / ▶ button, then to enter.

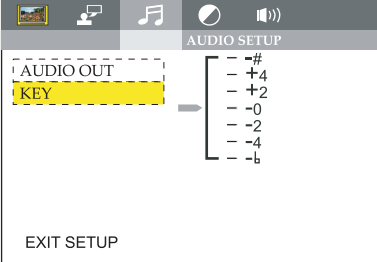

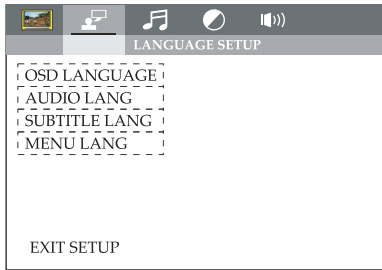

LANGUAGE SETUP

1. Press ▲ or ▼ button

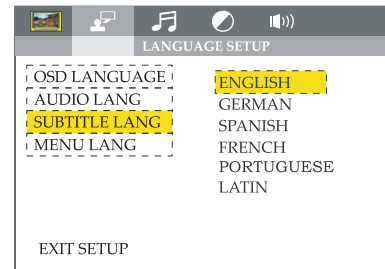
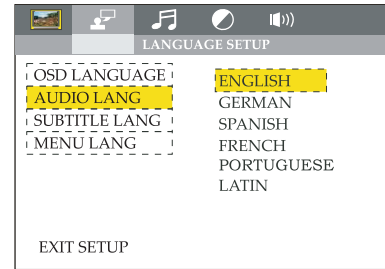
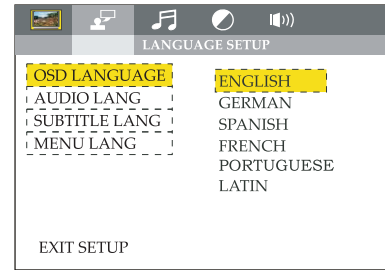

2. Press ▲/▼/◀/▶ button, then to enter.



VIDEO SETTING ON TOUCH SCREEN

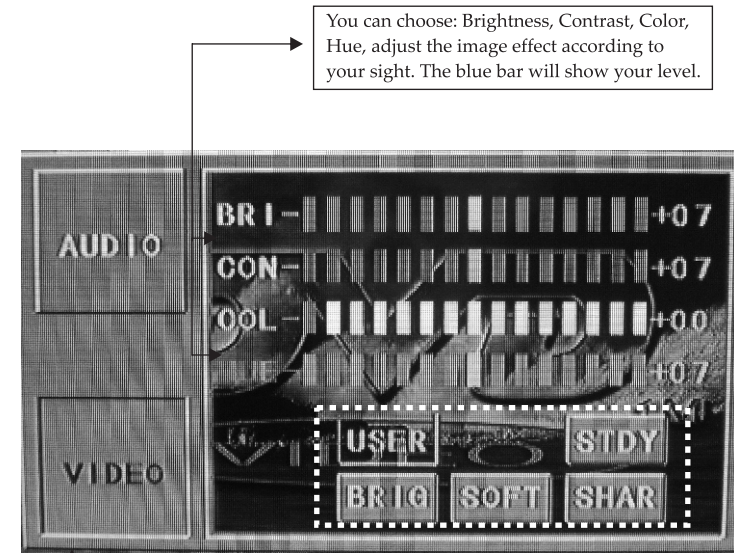

You can choose: Brightness, Contrast, Color, Hue, adjust the image effect according to your sight. The blue bar will show your level.

Video mode: When using this function, the position will be darker on the screen.

Image mode: You can choose the area in the broken line on the panel, standard, defined, soft, according what you need to choose, the blue back light will disappear.

Calibration to re-gain touch

✦ Please follow the below instructions to calibrate when there is no touch or touch is not accurate.

Step 1: Press the mode button in the unit to switch to DVD mode.

Step 2: Insert a DVD disc, after DVD is loaded, press the stop button “

Picture (1)



Picture (2)

Step 3: Press “

Picture (3)



Picture (4)

Step 4: Press “

Picture (5)

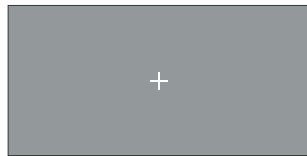

Picture (6)

Step 5: Use the touch pen to touch the center of the cross cursor, the cross cursor will move from the center to top left corner, top right corner, right down, left down, when the cross cursor stop at each corner, touch the center of the cursor. Then the panel will display OK and leave the calibration interface and the unit regained touch.



Picture (7)

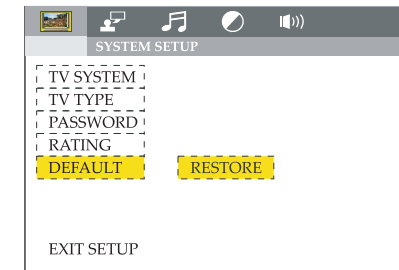
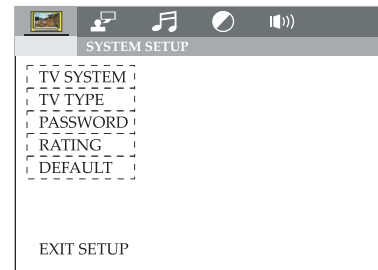
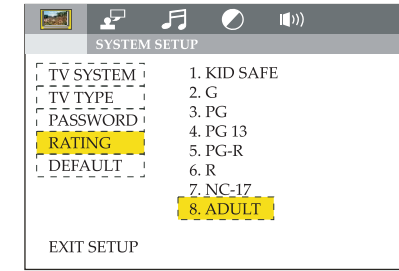
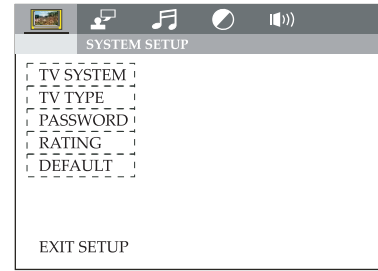

SYSTEM SETUP

1. Press ▲ or ▼ button

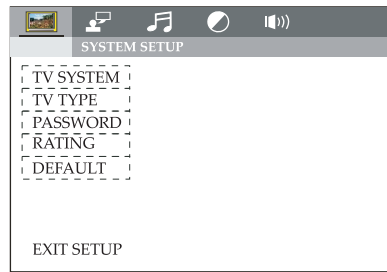

2. Press ▲ /▼/◀/▶ button, then to enter.

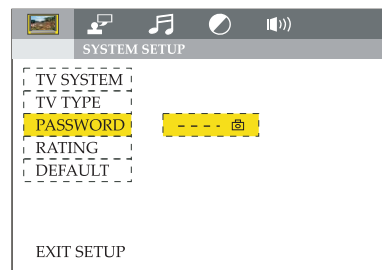
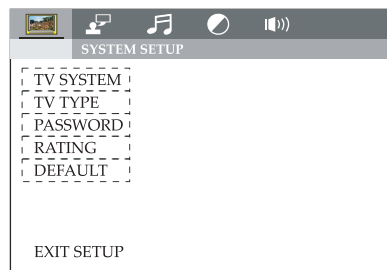
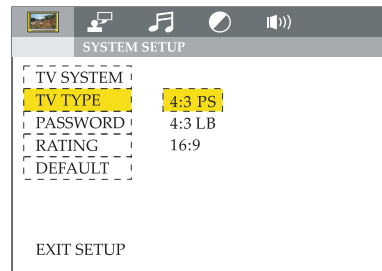
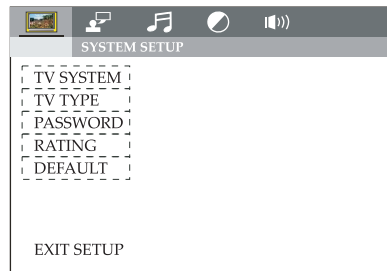
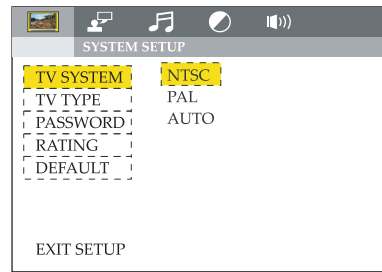

Note:

1. After input code "0000" press ENTER button to turn on child lock;
2. Move cursor to level item, choose desired level;
3. Only child lock is in can you choose.

9.DVD BASIC OPERATION

Slot in DVD disc, unit will play it automatically. If disc is in slot, press DVD touch button on main menu can to play.

1. Pause play

In playing mode, press ►|| button on remote control, or ►|| touchbutton on display to pause. Press again to back to normal play.

2. Stop play

In playing mode, 1) Press ■/> button on remote control to enter the pause mode, the position will be stored in unit. At that time, press ►|| button on remote control or touch button on display to resume playing at the stored position.

2) Press ■/> button on remote control twice to enter into stop mode, here, press ►|| button on remote control or touch button on display, unit will play from the first song.

3. Speed forward / backward play

In playing mode, press SEEK + button on remote control, or ►► touch button on display to speed play.

When you need quick back, press SEEK - button on remote control, or ◀◀ touch button on display to quick back play.

Note: Hold above button a bit longer to operate.

4. Previous / next song play

In playing mode, press SEEK + / SEEK - on remote control, or ►|/◀◀ touch button on display to choose previous/next song.

5. Switch system

In playing mode, short press the BAND/P/N button on remote control, to select PAL, AUTO, NTSC TV system.

Note: This function can only be worked by the remote control.

6. Slow play

Press SLOW button on remote control to slow play. The level of slow playing is as follows. Sequence is :

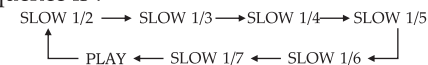

Note: This function can only be worked by the remote control.

7. Zoom in / Zoom out

Press ZOOM button on remote control to zoom in / zoom out the picture. The levels are as follows:

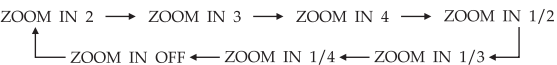

Note:

1. This function can only be worked by the remote control.
2. Image which is zoomed in can be moved by up/down/left/right cursor to move.
3. Image which is zoomed out cannot be moved.

